

# User Manual-Smart Digital Lock

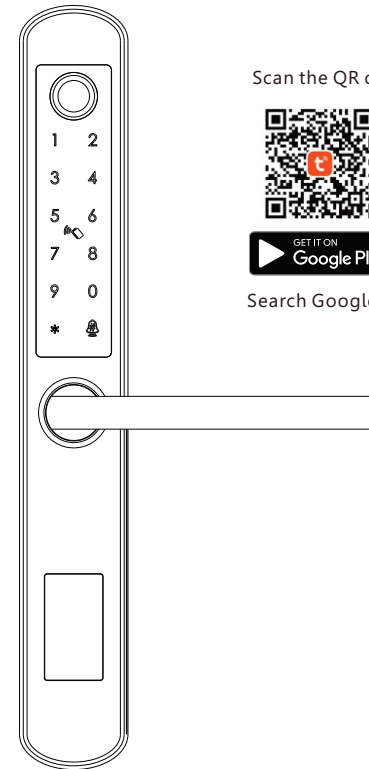

Scan the QR code below to download the APP



Search Google Play or APPLE Store with Tuyasmart



IC Card



Passcode



Key



APP



Fingerprint

## 1 SYSTEM INTRODUCTION

Material	304#stainless steel, ABS,arcylic
Available Color	Satin Nickle and Black Nickle
Door Thickness	38-55(mm)
Communication	Wi-Fi
Support OS	iOS 7.0 or above, Android 4.4 or above
Battery Life	7000 times normal open(10months around)
Power Supply	DC6V:4pcs AAA alkaline batteries
Static Current	<55uA
Dynamic Current	<200mA
Unlock Way	IC card, Passcode, fingerprint,APP, manual Key
Unlock Time	1-1.5seconds
Working Temperature	-20~45 degree
Working Humidity	10%~95%
IP Class	IP64(Not standard)
Available Mortise	2885/3585/4585/5085/6085/7085 Mortise
User Quantity	Password: 80 ; Card: 80 ; Fingerprint: 80 ;Administrator: 9 groups
Default Password	Default Password: 123456, press <b>123456+#</b> to unlock the door.

## 2 PRODUCT SPECIFICATION

### ■ Front Panel

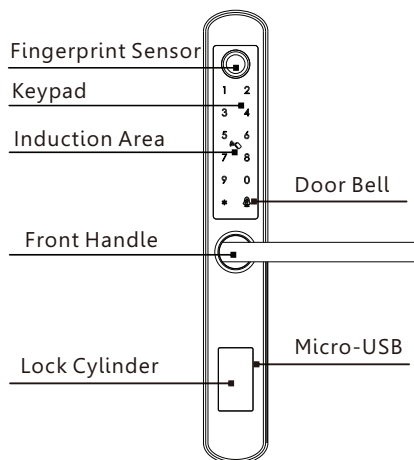

### ■ Back Panel

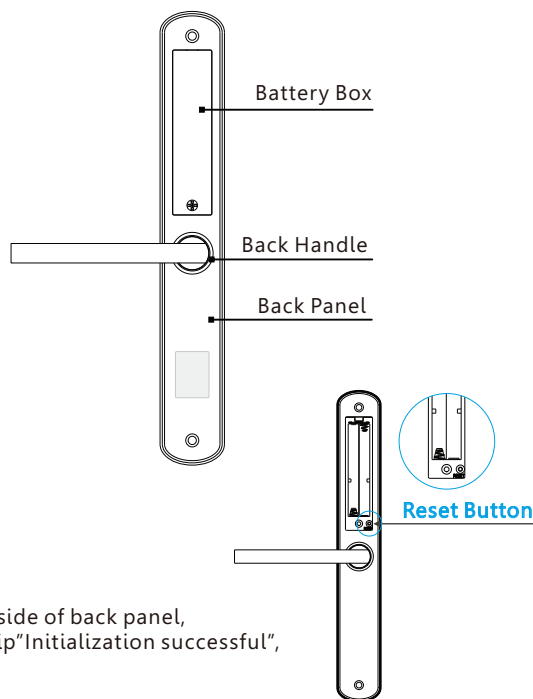









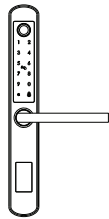
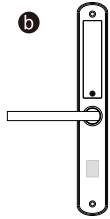
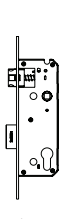

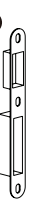
## 3 Reset to Factory State

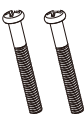

Long press the reset button (on the rear side of back panel, refer the photo) 5 seconds until sound tip "Initialization successful", default password is:123456.

## 4 PACKING LIST

<b>a</b>  1 Pcs Front Panel	<b>b</b>  1 Pcs Back Panel	<b>c</b>  1 Pcs Lock Mortise	<b>d</b>  1 Pcs Strike Plate	<b>e</b>  1 Pcs Strike Box			
<b>f</b>  1 Pcs Spindle	<b>g</b>  1 Pcs Cylinder Screw	<b>h</b>  4 Pcs Wood Screws	<b>i</b>  1 Pcs Battery Box Cover Screw	<b>j</b>  2 Pcs M4 Screws	<b>k</b>  2Pcs Epoxy Card	<b>m</b>  1 Pcs Cylinder	<b>n</b>  2 Pcs Manual Key

## 5 EXPLODED VIEW

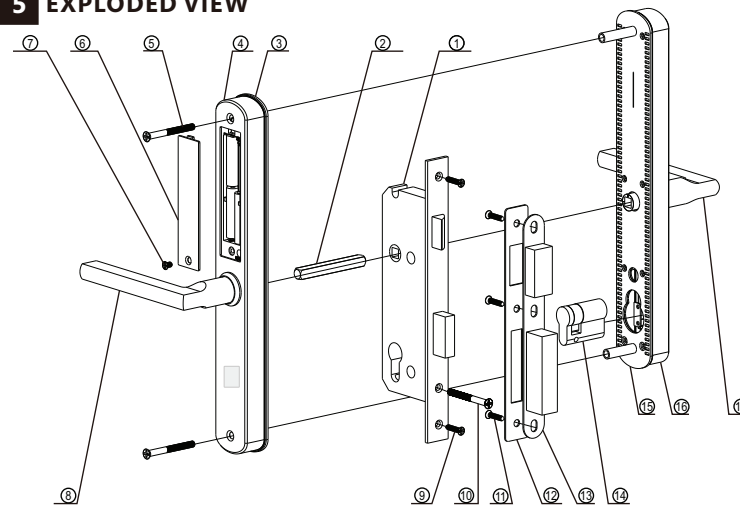

No.	Name	Quantity	No.	Name	Quantity
1	Mortise	1	10	Cylinder Screw	1
2	Spindle	1	11	Strike Screw	3
3	Rubber Gasket	1	12	Strike	1
4	Back Panel	1	13	Strike Box	1
5	Assemble Screw	2	14	Cylinder	1
6	Battery Box Cover	1	15	Front Gasket	1
7	Battery Cover	1	16	Front Panel	1
8	Back Handle	1	17	Front Handle	1
9	Faceplate Screw	2			

## 6 PREPARING FOR INSTALLATION

### 6.1 Line Drawing

Draw a horizontal center line inside and outside the door at 1 meter from the ground. Fold the template, make the handle center line align at the door horizontal center line, then draw out the hole lines at front and side.

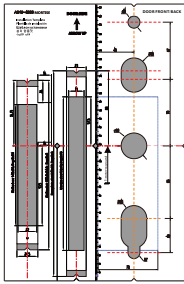

Template

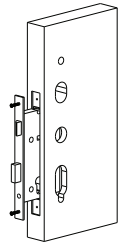

Trepanning



Screwdriver



### 6.2 Determining Lever Handing

The hand of the door is determined from the secure side of the door. The term secure means the side from which you initially unlock and enter from outside.

Stand outside of the door, choose the left/right direction with push or pull to unlock.

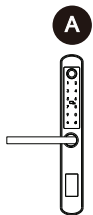
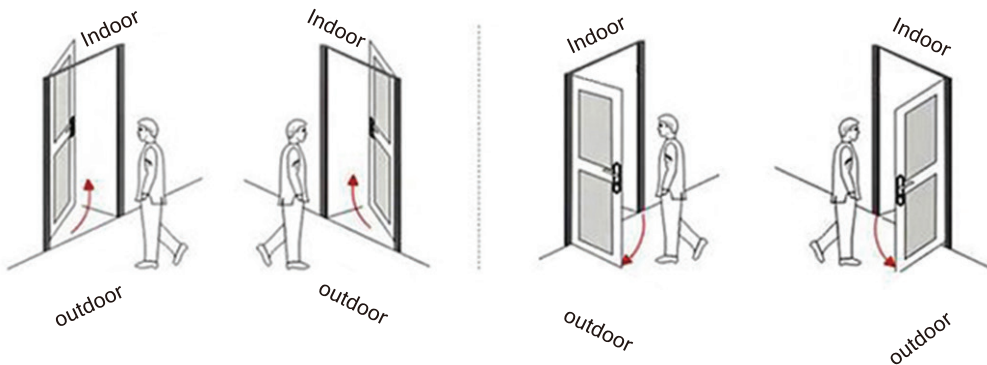

Left Push

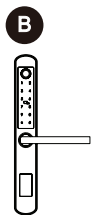

Right Push

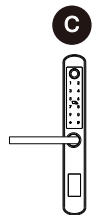

Left Pull

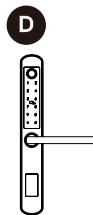

Right Pull

### 6.3 Change Handle Direction

#### 1. Adjust the Front Handle Direction

- 1.1 Use the allen key to take off the screw from the handle head.
- 1.2 Take off the handle.
- 1.3 Rotate the handle 180 degree and fix the direction that you need.
- 1.4 Tighten the screw with the allen key.
- 1.5 Adjust the clutch direction as the sign on the right.

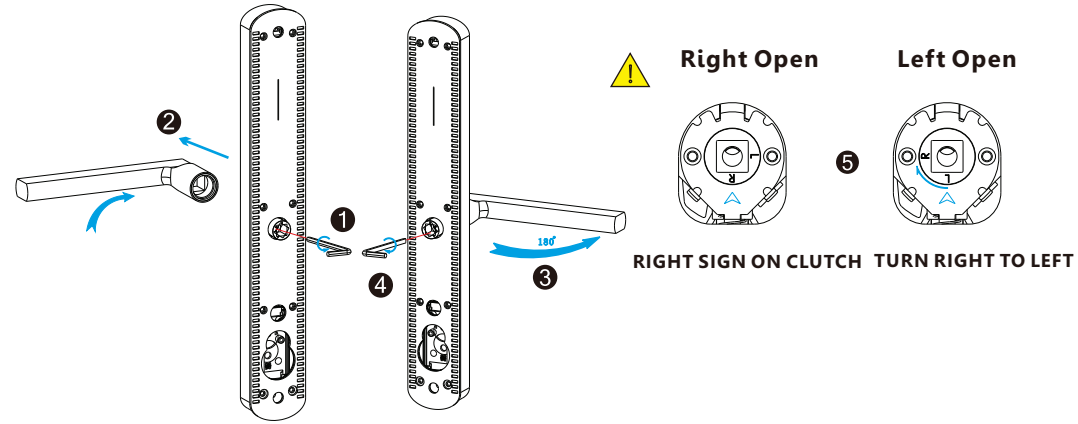

#### 2. Adjust the Back Handle Direction

- 2.1 Use the allen key to take off the screw from the handle head.
- 2.2 Take off the handle.
- 2.3 Rotate the handle 180 degree and fix the direction that you need.
- 2.4 Tighten the screw with the allen key.
- 2.5 Adjust the handle if it is too tight.

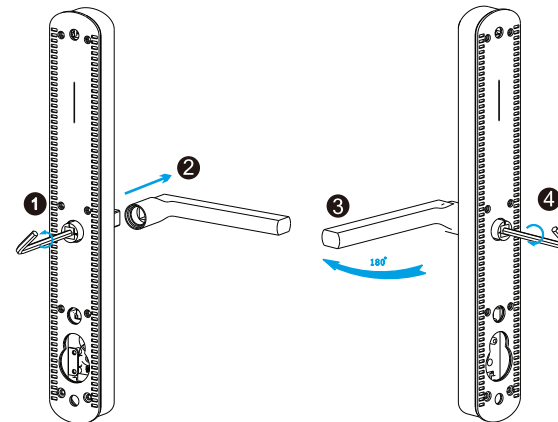

## 7 INSTALLATION STEPS:

### 7.1 Assemble the Mortise

Assemble the mortise(c) into the slot which is drilled according to the template.

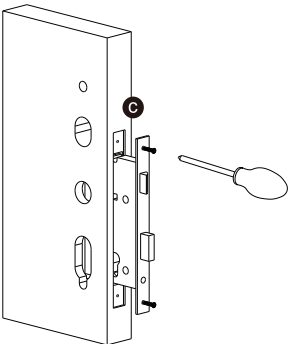

### 7.2 Assemble the Cylinder

Fix the cylinder(k) with the long screw through the hole on the faceplate.

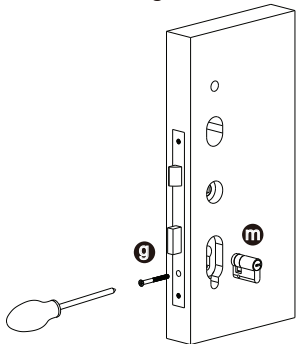

### 7.3 Assemble the Front Panel

Tight the front panel on the door(outside).

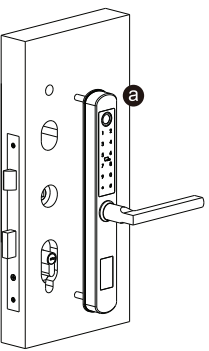

### 7.4 Assemble the back panel

Tight the back panel with front panel with the two long screws(j).

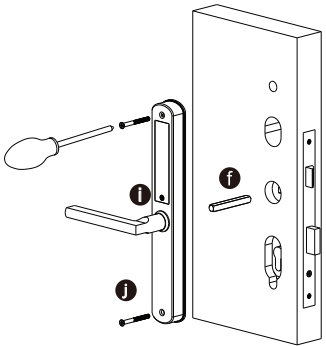

### 7.5 Assemble the Strike and Box

Put the strike box into the slot and fix the strike with the screws.

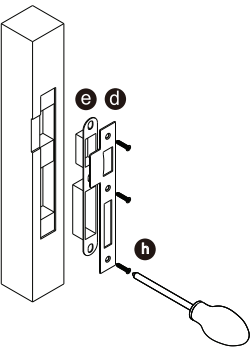

### 7.6 Test with the mechanical key

Test to unlock the door with the mechanical key and adjust the position if it is not smooth.

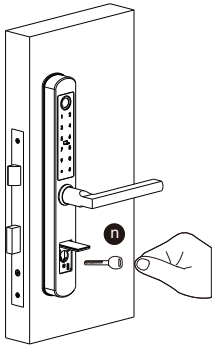

## OPERATION STEPS

Please enroll the master password/card/fingerprint before you start to use this lock. you can follow the operation steps as below, network setting can not be done under the default master password: 123456, you shall change master password first!

### 1.Initialization

**1** Press the reset button and hold 5 seconds

**2** "Initialization Successful"

### 2.Enroll Master Password

**1** Press \* and # button

**2** Please enter administrator fingerprint, tag or password

**3** Enter default Master password:123456+#

**4** Press 1 to set administrators  
Press 2 to set regular users  
Press 3 for system settings  
Press 4 to restore factory setting

**5** Press 1 to add administrators  
Press 2 to delete administrators  
Press 3 network settings

**6** Please enter administrator fingerprint, tag or password

Enter 4-8 digits new password,press # to confirm

**7** Please enter administrator fingerprint, tag or password





Enter same password  
Press # to confirm

**8** 00x, Input successful!  
Please enter administrator fingerprint, tag or password



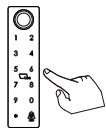

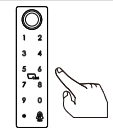
You can continue the operation to add master password

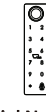
- ⚠ Notice: the administrator can be password/ fingerprint or IC card, you can set according to your own requirement, total 9 administrators.
- ⚠ Notice: Press # key to confirm, press \* to back to previous step, lock will exit the setting if there is no operation during 10 seconds.
- ⚠ Notice: After 5 times wrong unlock, the keypad will be locked for 60 seconds, there is no reaction for any operation during these time.

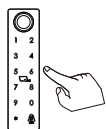

### 3.Delete Master Password

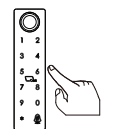
- 1 Press \* and # button  

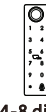
- 2 Please enter administrator fingerprint, tag or password  

- 3 Enter Master password, press # to confirm  

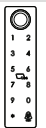
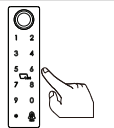
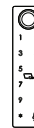
- 4 Press 1 to set administrators  
Press 2 to set regular users  
Press 3 for system settings  
Press 4 to restore factory setting  
 Press 1
- 5 Press 1 to add administrators  
Press 2 to delete administrators  
Press 3 network settings  
 Press 2
- 6 Please enter user serial no.  
  
Enter serial No. 001-009, press # to confirm
- 7 Operation Successful!  
You can continue the operation to delete master password



### 4.Enroll User Password

- 1 Press \* and # button  

- 2 Please enter administrator fingerprint, tag or password  

- 3 Enter Master password, press # to confirm  

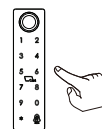
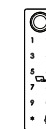
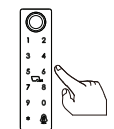
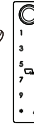
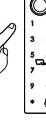
- 4 Press 1 to set administrators  
Press 2 to set regular users  
Press 3 for system settings  
Press 4 to restore factory setting  
 Press 2
- 5 Press 1 to add regular users  
Press 2 to delete regular users  
 Press 1
- 6 Please enter fingerprint, tag or password  
  
Enter 4-8 digits password, press # to confirm
- 7 Please enter again  
Enter same password Press # to confirm
- 8 01x,Input successful!  
Please enter fingerprint, tag or password  
You can continue the operation to issue user password





### 5.Delete User Password

- 1 Press \* and # button  

- 2 Please enter administrator fingerprint, tag or password  

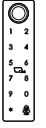
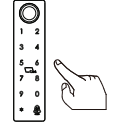
- 3 Enter Master password, press # to confirm  

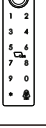
- 4 Press 1 to set administrators  
Press 2 to set regular users  
Press 3 for system settings  
Press 4 to restore factory setting  
 Press 2
- 5 Press 1 to add regular users  
Press 2 to delete regular users  
 Press 2
- 6 Press 1 to delete user No.  
Press 2 to delete all  
 Press 1  
Enter serial no. like 011, press # to confirm
- 7 Operation Successful!  
You can continue the operation to delete user password





### 6.Enroll User Card

- 1 Press \* and # button  

- 2 Please enter administrator fingerprint, tag or password  

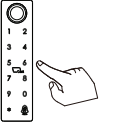
- 3 Enter Master password, press # to confirm  

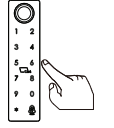
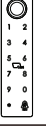
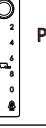
- 4 Press 1 to set administrators  
Press 2 to set regular users  
Press 3 for system settings  
Press 4 to restore factory setting  
 Press 2
- 5 Press 1 to add regular users  
Press 2 to delete regular users  
 Press 1
- 6 Please enter fingerprint, tag or password  
  
Touch one IC card to the induction area
- 7 01x,Input successful!  
Please enter fingerprint, tag or password  
You can continue the operation to add user cards.





## 7.Delete User Card

- 1 Press \* and # button  

- 2 Please enter administrator fingerprint, tag or password  

- 3 Enter Master password, press # to confirm  

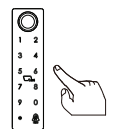
- 4 Press 1 to set administrators  
Press 2 to set regular users  
Press 3 for system settings  
Press 4 to restore factory setting  
 Press 2
- 5 Press 1 to add regular users  
Press 2 to delete regular users  
 Press 2
- 6 Press 1 to delete user No.  
Press 2 to delete all  
 Press 1  
Enter serial no. like 012,  
press # to confirm
- 7 Operation Successful!  
You can continue the operation to delete user card

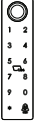
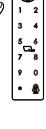



## 9.Delete User Fingerprint

- 1 Press \* and # button  

- 2 Please enter administrator fingerprint, tag or password  

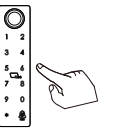
- 3 Enter Master password, press # to confirm  

- 4 Press 1 to set administrators  
Press 2 to set regular users  
Press 3 for system settings  
Press 4 to restore factory setting  
 Press 2
- 5 Press 1 to add regular users  
Press 2 to delete regular users  
 Press 2
- 6 Press 1 to delete user No.  
Press 2 to delete all  
 Press 1  
Enter serial no. like 013,  
press # to confirm
- 7 Operation Successful!  
You can continue the operation to delete user fingerprint

## 8.Enroll User Fingerprint

- 1 Press \* and # button  

- 2 Please enter administrator fingerprint, tag or password  

- 3 Enter Master password, press # to confirm  

- 4 Press 1 to set administrators  
Press 2 to set regular users  
Press 3 for system settings  
Press 4 to restore factory setting  
 Press 2
- 5 Press 1 to add regular users  
Press 2 to delete regular users  
 Press 1
- 6 Please enter fingerprint, tag or password  

- 7 Press fingerprint 4 times
- 8 01x,Input successful!  
Please enter fingerprint, tag or password  
You can continue the operation to issue user fingerprint

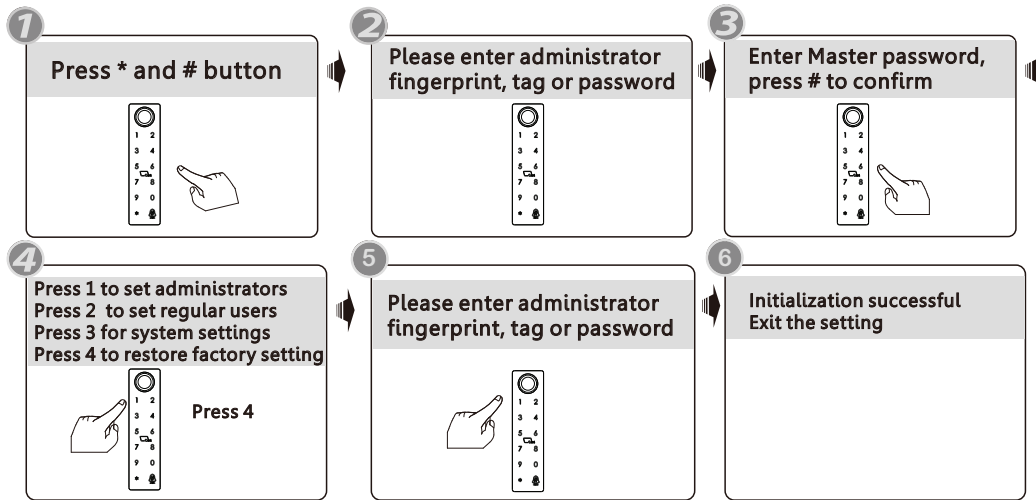
## 10.System Setting

- 1 Press \* and # button  

- 2 Please enter administrator fingerprint, tag or password  

- 3 Enter Master password, press # to confirm  

- 4 Press 1 to set administrators  
Press 2 to set regular users  
Press 3 for system settings  
Press 4 to restore factory setting  
 Press 3
- 5 Press 1 for voice setting  
Press 2 for unlock mode  
Press 3 to select language  
Press 4 to set time
- 6 **Press 1:** Disable or enable the sound tip.  
**Press 2:** Choose single authentication or double authentication  
Enable/disable passage mode  
**Press 3:** Choose English or Chinese  
**Press 4:** Change lock time

You can make the settings following the sound tip for the unlock type /Language/Lock time etc, these functions are designed for some special conditions.

## 11.Reset Setting



**Notice:** Above are the standard operation for the lock with password and keycard function. If you need to use the remote unlock function, you shall use the Tuya smart app to connect the device and make the settings accordingly.

## 12.Tuya APP Settings

Please download the Tuya smart or Smart life on Apple store or Google play. also you can scan the QR code below to download the APP directly.



### 12.1 Please register one account with your E-mail or mobile number.

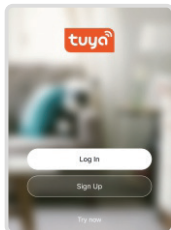

12.2.1 Sign Up

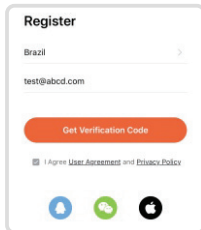

12.2.2 Enter mobile or mail  
Get Verification Code

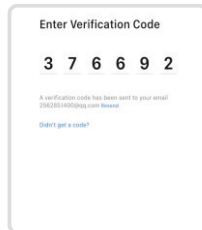

12.2.3 Enter the code sent to  
your mail or mobile

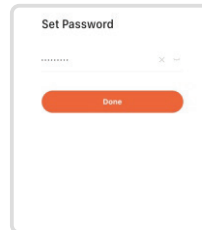

12.2.4 Set password and  
login

## 12.2 Network Setting

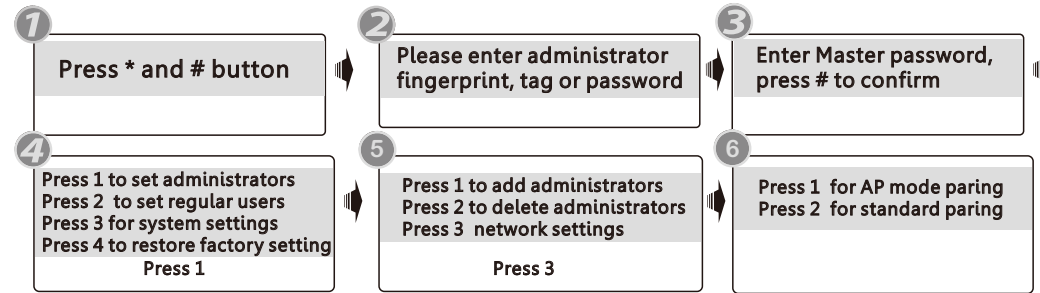

**Notice:** There are two type of connections under the manual: AP mode pairing and standard pairing or Bluetooth connection (dual module).

### 12.3 Standard Pairing (EZ mode)

Please run the Tuya smart APP and choose the WiFi lock under the "Security&Sensors". please ensure the privacy button is under unlock state, if it is under lock state, you can not configure the Wi-Fi connection.

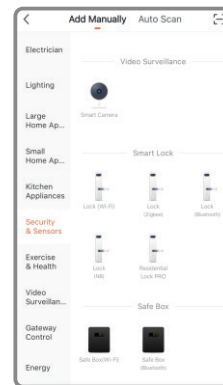

Step 1

Choose the Lock(WiFi) under the category "Security&Sensors"

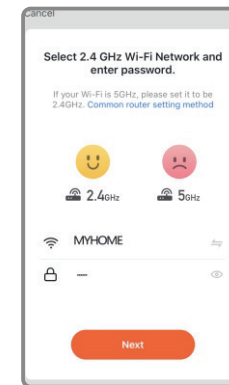

Step 2

Enter the password of the WiFi and click Next.



Step 3

Confirm the number 5 blinking rapidly, and click Next.

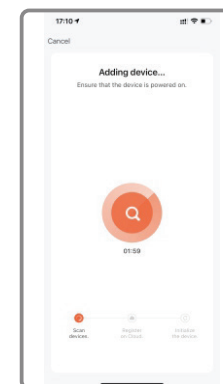

Step 4

Scan the device



Step 5

Add device successfully

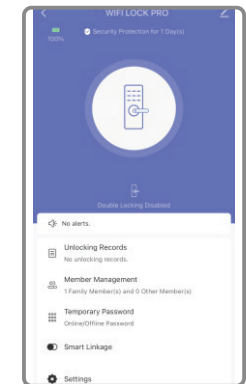

Step 6

Interface, can edit lock name

## 12.4 Hotspot Connection(AP mode)

Please run the Tuya smart APP and choose the WiFi lock under the “Security&Sensors”.

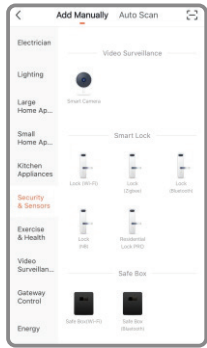

Step 1

Choose the Lock(WiFi) under the category “Security&Sensors”

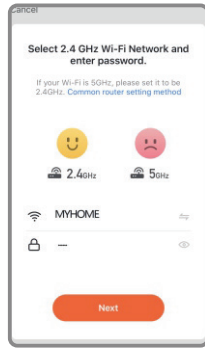

Step 2

Enter the password of the WiFi of your home and click Next.

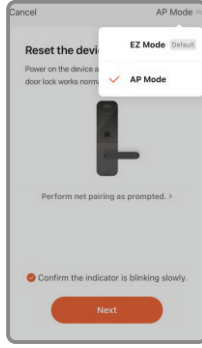

Step 3

Choose AP mode under the right top option



Step 4

Confirm the number 5 blinking rapidly, and click Next.

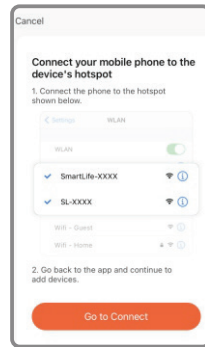

Step 5

Connect the hotspot of mobile click Go to Connect



Step 6

Find the SmartLife-xxx and connect

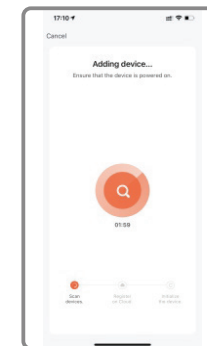

Step 7

Scan the device



Step 8

Add device successfully

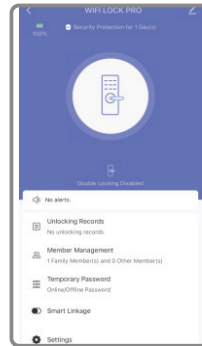

Step 9

Interface,can edit lock name

## 12.5 Quick Connection by BLE

This is one extra way for connection by BLE. This operation shall be done for the lock that under AP or EZ mode state(Number 5 flashing). there is one window pop up as below:

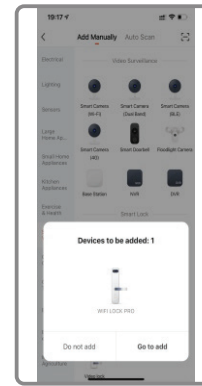

Step 1

Pop up the window with device to add



Step 2

Enter the Wi-Fi password and click Next.

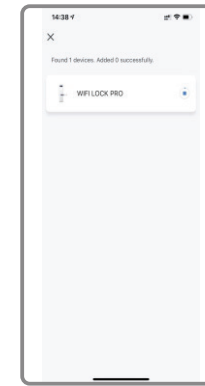

Step 3

Place mobile near the router and register lock to cloud



Step 4

Connected

## 12.6 Remote Unlock Function

When the visitor press the number 9 and # by sequence, there is one remote unlock request send to the administrator in the App as the photo, you can press the “Agree” to unlock the door or reject to cancel the operation.

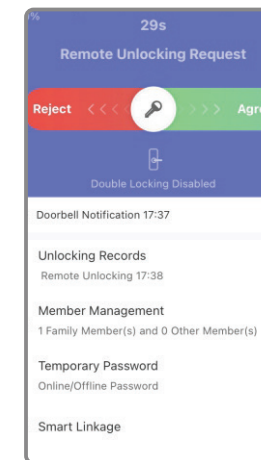
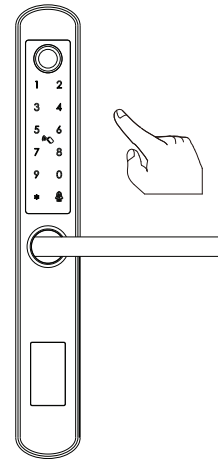



## 12.7 Online Password Function

When the visitor visit your office or home, you can generate the temporary password with valid time period, refer the below operation step. Also you can check the unlock record in the APP window.

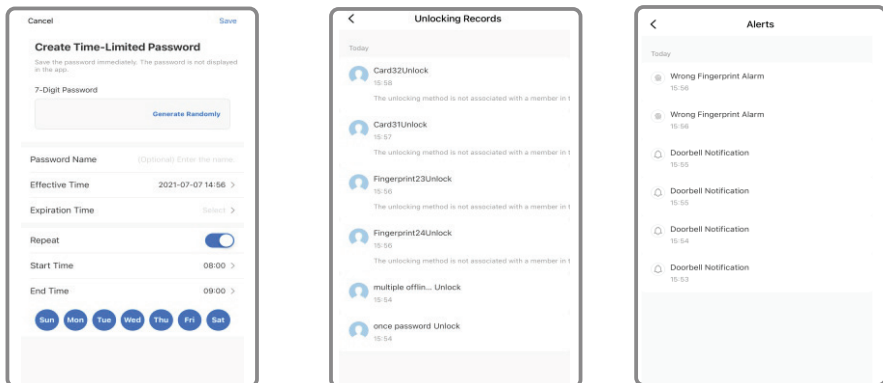

## 12.8 Offline Password Function

There is one-time password and time-limited password for offline type passwords. you can choose to generate the one-time password like below, it is only valid for 6 hours, and time-limited password within 24 hours before it expires, please use this password on the lock before it expires.

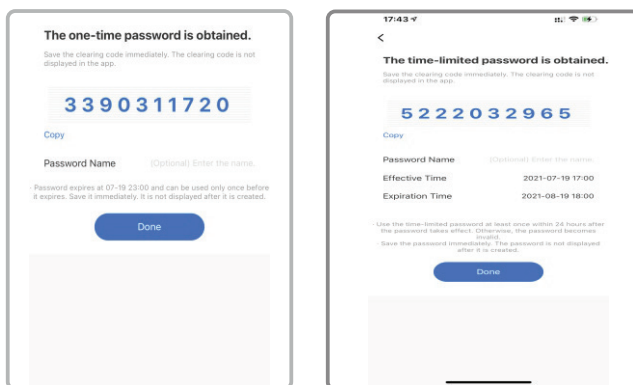

The one-time password and time-limited password for offline type password can not work when the lock is under dead lock state, only the administrator (fingerprint/password or card user) can access during this state.

## 12.9 Smart Linkage Function

You can choose the feature and message notification method upon the using condition. Such as family go home/door lock alarm/unlock on arrival/lock on departure.

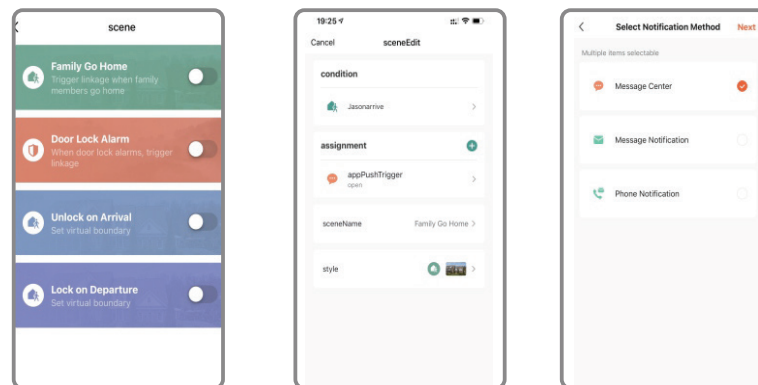

There is also one smart linkage feature with your smart Tuya products. You can click the assignment and find the scene device, under this option, you can link other tuya smart devices together, for sample the LED bulb, when you press the handle to unlock the door at night time, the LED bulb light will turn on together.

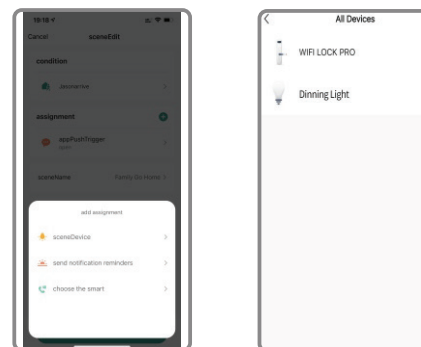

**Attention**

### Special Remark for Network Function

**Please enroll the new master password/card/fingerprint before you start to use this lock. you can follow the operation steps with this manual, network setting can not be done under the default master password: 123456, you shall change master password first!**

## **13 INFORMATION AND SAFETY WARNINGS:**

### **13.1 Introduction**

This user manual will guide you through the functions and usages of our A210 smart lock. It is important that you follow the instructions and regard all notes that appear throughout this manual. Consult this manual before you attempt to use this lock. If you have any questions that not answered by this manual or on need of non-routine service, please call our customer service hotline or send FAQ to us.

### **13.2 Safety Warnings:**

 When reading this manual, note these icons: notes with the icon Must be read, understood and obeyed to prevent injury or damage to the lock.

#### **General Usage**

- This lock shall only be used as described in this manual.
- Verify that all parts of the lock are accounted for. If any parts are missing, please contact our service person.
- There is protective film on the front touch panel, if there are some scratches on the film, please remove the film if you need.
- Please use 4pcs AAA batteries. Do not mix old and new batteries or other Zn/Mn batteries. Never insert objects into the lock other than batteries as described in this manual.
- Verify all surfaces are flat and level before beginning installation, installation on doors or surface with any types of deformity such as gaps or warping may cause the lock to malfunction or fail to operate entirely.
- Never apply any cleaner directly to any part of this lock. Only use clean water or mild cleaner on a soft non-abrasive cloth when cleaning.
- The lock must be used with Tuyasmart APP. The lock will function without the APP but full functionality may only be achieved when the APP is on use.

### **13.3 SALES AND SERVICE TERMS**

- Please read the manual carefully before use!  
Limited 1-year Electronic Warranty Limited Lifetime Mechanical and Finish Warranty
- This A210 product comes with a 1-year Limited Warranty on Electronic Parts and a Limited lifetime. Mechanical and Finish Warranty against defects in materials and workmanship under normal use to the original residential user. Proof of purchase and ownership is required for the warranty to be in effect.
- Any error or question in our manual or sales term, please feel free to contact with us.
- For any wrong operation or installation to the user, we do not responsible for the duty.
- For the damage caused by anthropic factor or inevitable reason, we do not pay for the loss or maintain for free, please check our after sale service terms.
- Please do not take apart the lock if you are not technician, if necessary, please make the operations under the guide of technician.
- Notice: there maybe a little difference for product pictures with real product, please subject to our real products.